

CONTROL BOX MG569

3002949
3002967

The new control box **MG569** is installed on either single or double stage burners, (see fig. 1).

EQUIPMENT

Control box MG569	N° 1
Leads RS	N° 1
Leads SO	N° 1
Protection V2	N° 1
Assembly connection (only for code 3002949)	N° 1
Instruction	N° 1

ATTENTION

The assembly connection (fig. 6, page 2) must be used only if a control box model 525SE/G, 566SE, 566SE Rev. 1 and 566SE Rev. 2 needs to be replaced.

INSTALLATION

Trained personnel must carry out the substitution of the control box. It is necessary to switch off the main power supply before effecting any substitution.

To install the new **MG569** control box, it is necessary to use the diagram below.

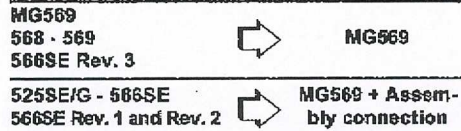

To install, proceed as follows:

- Unscrew the fixing screws and remove the burner cover.
- Disconnect all connections, the 7-pin plug, the ionization probe, the H.T. lead and the earth wire from the control box.
- Remove the control box from the burner by unscrewing the screws (A, fig. 3) and pull in the direction of the arrow.
- Install the new control box supplied by fastening it to the burner by the screw (A, fig. 3), with a torque wrench setting of 1 - 1.2 Nm.
- Reconnect all connections, the 7-pin plug and the earth wire.

REMOTE RESET CONNECTION, (fig. 4)

If the burner has a remote reset, you must proceed as follows:

- Cut the existing socket-connection.
- Carry out the new connection (RS, see electrical wiring page 3).
- Connect a button at 20 m. max.

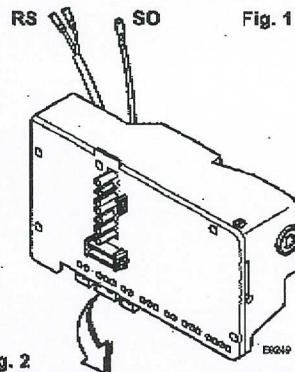
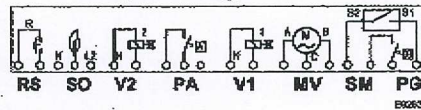

Fig. 2



KEY TO LAY-OUT, (fig. 2)

- SM- Servomotor (for burners designed)
- PG- Gas pressure switch
- MV- Motor
- V1 - 1st stage valve
- PA- Air pressure switch
- V2 - Protection
- SO - Ionisation probe
- RS - Remote reset

Fig. 3

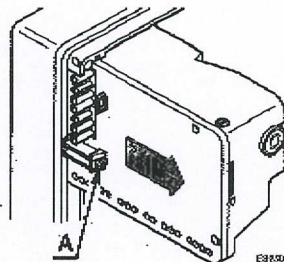
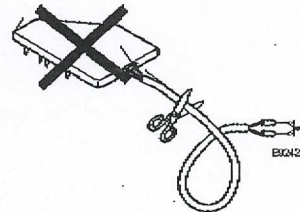

Fig. 4



ASSEMBLY CONNECTION

For burners with control boxes 525SE/G, 566SE, 566SE

Rev. 1 and Rev. 2, make as following:

- Remove the suppressor connection (fig. 5);
- Use the assembly connection (fig. 6) as the following instructions.

Fig. 5

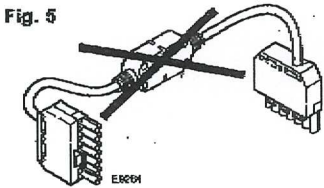

SINGLE STAGE BURNERS Type 911T - 912T - 913T - 914T

- Disconnect the 6 pin plug of the gas train from the 6 pole socket of the burner.
- Disconnect all the control box's connections.
- Disassemble the 6 pole socket and the respective connection.
- Disconnect control box from the burner by unscrewing the screw (A, fig. 3, page 1) and pull in the direction indicated by the arrow.
- Fasten the new socket (XP6), instead of the previous one.
- Connect the yellow/green wire (D) to the earth clamp of the burner.
- Install the new control box, fastening it to the burner by means of the screw (A, fig. 3, page 1) with a driving torque of 1 to 1.2 Nm.
- Insert the four-way connector (B) in the control box (SM-PG).
- Insert the two-way connector (A) in the control box (V1).
- Make the rest of the connections to the control box.

NOTE

The wires (F - G, fig. 6) are bound by a clip these wires are useless for these burners.

TWO STAGE BURNERS Type 915T - 916T - 917T - 918T

- Disconnect the 6 pin plug of the gas train from the 6 pole socket of the burner.
- Disconnect all the control box's connections.
- Disassemble the 6 pole socket and the respective connection.
- Disconnect control box from the burner by unscrewing the screw (A, fig. 3, page 1) and pull in the direction indicated by the arrow.
- Remove the two-way connection from the control box (V1), disconnect the blue wire (of the servomotor) and cut the other wire by removing the red connector.
- Fasten the new socket (XP6), using the screws of the previous one.
- Connect the yellow/green wire (D) to the earth clamp of the burner.
- Install the new control box, fastening it to the burner by means of the screw (A, fig. 3, page 1) with a driving torque of 1 to 1.2 Nm.
- Insert the four-way connector (B) in the control box (SM-PG).
- Insert the two-way connector (A) in the control box (V1).
- Connect the blue and black wires (G) with the respective blue and black wires of the servomotor.
- Join the blue wire of the cable of the external 4 pole socket (XP4), with the adjustable clamp (F).

Fig. 6

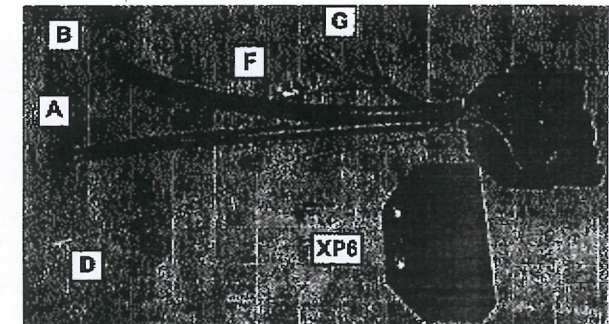

ATTENTION:

- Once you have done, make sure the burner is working properly, checking that the burner shuts down when the low-limit gas pressure switch opens and checking switching between first and second stage with the aid of the relevant thermostat.
- In the event of firing or operation problems, press the lock-out reset button. This can be repeated 3 times maximum.

ELECTRICAL WIRING

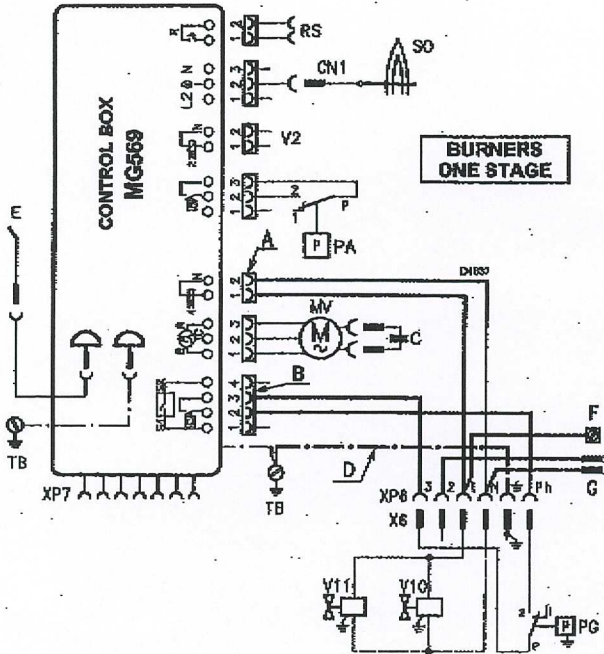

- KEY TO LAY-OUT**
- A - Two-way connector
 - B - Four-way connector
 - D - Earth wire
 - G - Connectors for servomotor
 - F - Adjustable clamp
 - B5 - Working signal 2nd stage
 - C - Capacitor
 - CN1 - Probe connector
 - E - Electrode
 - h2 - 2nd stage hour counter
 - MV - Motor
 - PA - Min. air pressure switch
 - PG - Min. gas pressure switch
 - RS - Remote reset
 - SM - Servomotor
 - SO - Probe ionization
 - TR - Adjusting the thermostat
 - TB - Burner earth
 - V2 - Protection
 - V10 - Safety valve
 - V11 - 1st stage valve
 - V12 - 2nd stage valve
 - X. - Socket
 - XP. - Plug
 - ↑ - Black
 - 2 - Blue
 - 3 - Brown

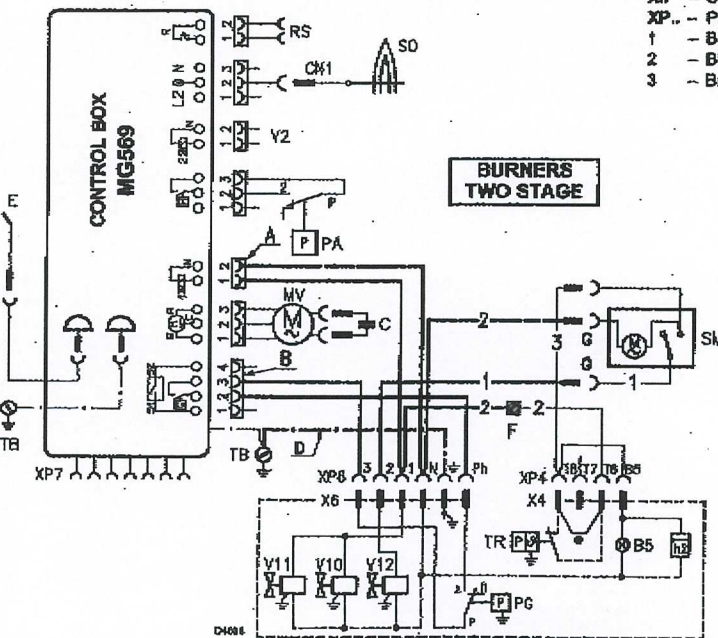

VISUAL DIAGNOSTIC CONTROL BOX

The control box has a diagnostic function that can identify the likely causes of any malfunctions (indicator: RED LED). In order to be able to use this function, press and hold the reset button for at least 3 seconds from when the appliance is made safe (lock-out). The control box sends a sequence of pulses that are repeated at 2-second intervals.

RED LED illuminated press reset for 3 sec.	Pulses	Interval 2s	Pulses

The sequence of pulses issued by the control box identifies the possible types of malfunction, which are listed in the table below.

--	--	--	--

<p>2 pulses</p> <p>••</p>	<p>The flame does not stabilise at the end of the safety time:</p> <ul style="list-style-type: none"> - faulty ionisation probe; - faulty or soiled gas valves; - neutral/phase exchange; - faulty ignition transformer - poor burner regulation (insufficient gas).
<p>3 pulses</p> <p>•••</p>	<p>Min. air pressure switch does not close or is already closed before the limit thermostat closed:</p> <ul style="list-style-type: none"> - air pressure switch faulty; - air pressure switch incorrectly regulated.
<p>4 pulses</p> <p>••••</p>	<p>Light present in the chamber before the burner's switching on or off:</p> <ul style="list-style-type: none"> - presence of a strange light before or after the limit thermostat switching over; - presence of a strange light during pre-ventilation; - presence of a strange light during post-ventilation.
<p>6 pulses</p> <p>••••••</p>	<p>Loss of ventilation air:</p> <ul style="list-style-type: none"> - air loss during pre-ventilation; - air loss during and after safety time.
<p>7 pulses</p> <p>•••••••</p>	<p>Loss of flame during operations:</p> <ul style="list-style-type: none"> - poor burner regulation (insufficient gas); - faulty or soiled gas valves; - short circuit between ionisation probe and earth.

ATTENTION To reset the control box after the diagnostics display, press the lockout-reset button.

RE-CYCLE FUNCTION

The control box allows re-cycling, i.e. the complete repetition of the starting programme, for 3 attempts maximum, in the event the flame goes out during operation.

POST-VENTILATION FUNCTION

Post-ventilation is a function that maintains air ventilation even after the burner is switched off. The burner switches off when the limit thermostat (TL) opens, cutting off the fuel supply to the valves.

To use this function the reset button must be pressed when the limit thermostat is not switched over (BURNER SWITCHED OFF).

Post-ventilation time can be set to a maximum of 6 minutes. Proceed as follows:

- > Press and hold the reset button for at least 5 seconds till the LED indicator changes to red.
- > Set the desired time pressing the button repeatedly: **once = post-ventilation for 1 minute.**
- > After 5 seconds the control box automatically shows the minutes set by the red LED flashing:
1 pulse = post-ventilation for 1 minute.

To reset this function, press and hold the button for at least 5 seconds at least, till the LED indicator changes to red then release it without carrying out any operation, then wait for 20 seconds for the burner to start.

If during post-ventilation there is a new request for heat, post-ventilation time is halted and a new operating cycle starts when the limit thermostat (TL) switches over.

The control box leaves the factory with the following setting: **0 minutes = no post-ventilation.**

CONTROL BOX RESET

To carry out the control box reset, proceed as follows:

- > Press the reset button for at least 1 second.

In the event of the burner not restarting it is necessary to check if the limit thermostat (TL) is closed.